

VLINX FIELDBUS GATEWAY



FOR USE IN HAZARDOUS LOCATIONS:
 Class I, Division 2, Groups A, B, C, and D

- *PROTOCOL CONVERSION FEATURE CONVERTS NUMEROUS PROTOCOLS SIMULTANEOUSLY*
- *COMPACTFLASH® SLOT ALLOWS PROCESS DATA TO BE LOGGED DIRECTLY TO CSV FILES*
- *VIRTUAL HMI OFFERS BUILT-IN PC-BASED SCADA FUNCTIONALITY*
- *WEBSERVER PROVIDES WORLDWIDE ACCESS TO DATA LOGS AND VIRTUAL HMI*
- *EXTENSIVE BUILT-IN DRIVER LIST ALLOWS EASY DATA MAPPING TO PLCs, PCs, AND SCADA SYSTEMS*
- *ALARM NOTIFICATIONS CAN BE SENT VIA EMAIL OR TEXT MESSAGES*
- *10 BASE-T/100 BASE-TX ETHERNET CONNECTION CAN CONNECT TO AN UNLIMITED NUMBER OF DEVICES VIA FOUR PROTOCOLS SIMULTANEOUSLY*



GENERAL DESCRIPTION

The Vlinx Fieldbus Gateway was designed to act as a nexus for industrial data collection and management. The unit offers multiple protocol conversion, data logging and remote machine access. With three built in serial ports and a 10 Base-T/100 Base-TX Ethernet port, the unit performs protocol conversion, allowing disparate devices to communicate seamlessly with one another. The Ethernet port supports up to four protocols simultaneously so even Ethernet to Ethernet protocols can be converted.

The CompactFlash card allows data to be collected and stored for later review. The files are stored in simple CSV file format allowing common applications, such as Microsoft Excel and Access, to view and manage the data. The free Websync utility provides a means to synchronize the files with a PC's hard drive for permanent storage. The CompactFlash card may also be used to load new configuration files into the Fieldbus Gateway.

The built-in web server allows log files to be retrieved manually, and also provides access to the unique "virtual HMI". Any standard web browser such as Internet Explorer or Netscape may be used to monitor or control the HMI from a PC anywhere in the world.

The USB port may be used for blazing fast file downloads, or to mount the Fieldbus Gateway's CompactFlash card as an external drive to your PC.

The Fieldbus Gateway's DIN rail mounting saves time and panel space and snaps easily onto standard top hat (T) profile DIN rail.

SOFTWARE

The Vlinx Fieldbus Gateway is programmed with Fieldbus Gateway Manager for Windows® 2000 or later platforms. The software is an easy to use graphical interface which can be purchased as part of a kit that includes a manual and cables, or downloaded free of charge.

SAFETY SUMMARY

All safety related regulations, local codes and instructions that appear in the manual or on equipment must be observed to ensure personal safety and to prevent damage to either the instrument or equipment connected to it. If equipment is used in a manner not specified by the manufacturer, the protection provided by the equipment may be impaired.

Do not use the controller to directly command motors, valves, or other actuators not equipped with safeguards. To do so can be potentially harmful to persons or equipment in the event of a fault to the controller. An independent and redundant temperature limit indicator with alarm outputs is strongly recommended.

CAUTION: Risk of Danger.
 Read complete instructions prior to installation and operation of the unit.

WARNING - EXPLOSION HAZARD - SUBSTITUTION OF COMPONENTS MAY IMPAIR SUITABILITY FOR CLASS I, DIVISION 2

THIS EQUIPMENT IS SUITABLE FOR USE IN CLASS I, DIVISION 2, GROUPS A, B, C, D, OR NON-HAZARDOUS LOCATIONS ONLY

CompactFlash is a registered trademark of CompactFlash Association.

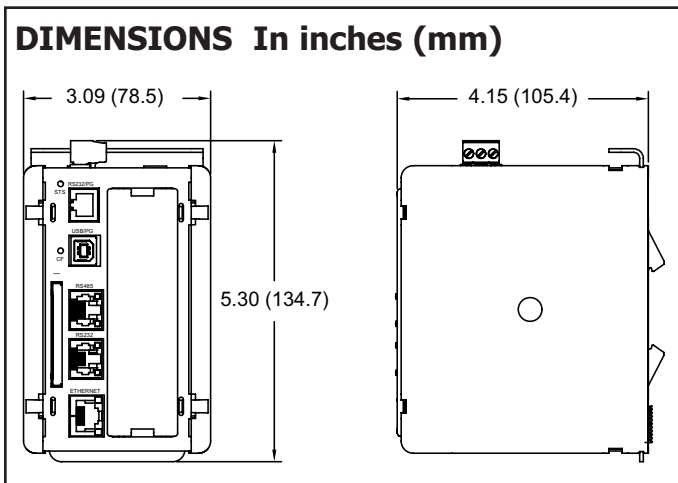

SPECIFICATIONS

- POWER:** 24 VDC \pm 10%
200 mA min., without expansion card
1 Amp maximum with expansion card fitted
Must use NEC Class 2 or Limited Power Source (LPS) rated power supply.
- COMMUNICATIONS:**
USB/PG Port: Adheres to USB specification 1.1. Device only using Type B connection.

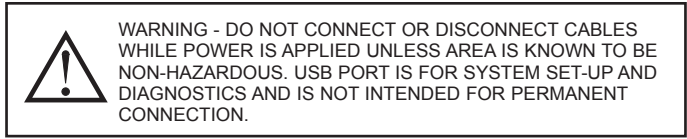

- Serial Ports:** Format and Baud Rates for each port are individually software programmable up to 115,200 baud.
- RS232/PG Port:** RS232 port via RJ12
- COMMS Ports:** RS422/485 port via RJ45, and RS232 port via RJ12
- DH485 TXEN:** Transmit enable; open collector, $V_{OH} = 15$ VDC, $V_{OL} = 0.5$ V @ 25 mA max.
- Ethernet Port:** 10 BASE-T / 100 BASE-TX
RJ45 jack is wired as a NIC (Network Interface Card).
- LEDs:**
STS – Status LED indicates condition of Fieldbus Gateway.
TX/RX – Transmit/Receive LEDs show serial activity.
Ethernet – Link and activity LEDs.
CF – CompactFlash LED indicates card status and read/write activity
 - MEMORY:**
On-board User Memory: 4 Mbytes of non-volatile Flash memory.
On-board SDRAM:
VFG2: 2 Mbytes
VFG3: 8 Mbytes
Memory Card: CompactFlash Type II slot for Type I and Type II cards.
 - REAL-TIME CLOCK:** Typical accuracy is less than one minute per month drift. Crimson 2.0's SNTP facility allows synchronization with external servers.
Battery: Lithium Coin Cell. Typical lifetime of 10 years at 25 °C.
A "Battery Low" system variable is available so that the programmer can choose specific action(s) to occur when the battery voltage drops below its nominal voltage.
This unit is NOT field serviceable. All work must be done by a qualified technician.
 - ENVIRONMENTAL CONDITIONS:**
Operating Temperature Range: 0 to 50°C
Storage Temperature Range: -30 to +70°C
Operating and Storage Humidity: 80% max relative humidity, non-condensing, from 0 to 50°C
Vibration According to IEC 68-2-6: Operational 5 to 150 Hz, in X, Y, Z direction for 1.5 hours, 2 g's.
Shock According to IEC 68-2-27: Operational 30 g, 11 msec in 3 directions.
Altitude: Up to 2000 meters

- CONSTRUCTION:** Case body is high impact plastic and stainless steel. For indoor use only. Installation Category II, Pollution Degree 2.
- POWER CONNECTION:** Removable wire clamp screw terminal block.
Wire Gage Capacity: 24 AWG to 12 AWG
Torque: 4.45 to 5.34 in/lb (0.5 to 0.6 N-m)
- MOUNTING:** Snaps onto standard DIN style top hat (T) profile mounting rails according to EN50022 -35 x 7.5 and -35 x 15.
- CERTIFICATIONS AND COMPLIANCES:**

SAFETY

UL Listed, File #E222870, UL508, CSA 22.2 No. 14-M05 and File #E245458, ANSI/ISA 12.12.01-2007, CSA 22.2 No. 213-M1987
LISTED by Und. Lab. Inc. to U.S. and Canadian safety standards IEC 61010-1, EN 61010-1: Safety requirements for electrical equipment for measurement, control, and laboratory use, Part 1.

ELECTROMAGNETIC COMPATIBILITY

Emissions and Immunity to EN 61326: 2006: Electrical Equipment for Measurement, Control and Laboratory use.

Immunity to Industrial Locations:

Electrostatic discharge	EN 61000-4-2	Criterion B 4 kV contact discharge 8 kV air discharge
Electromagnetic RF fields	EN 61000-4-3	Criterion A 10 V/m
Fast transients (burst)	EN 61000-4-4	Criterion A power 2 kV I/O signal 1 kV
Surge	EN 61000-4-5	Criterion B power 1kV L-L, 2 kV L-G signal 1kV
RF conducted interference	EN 61000-4-6	Criterion A 3 V/rms

Emissions:

Emissions	EN 55011	Class A
-----------	----------	---------

Notes:

- Criterion A: Normal operation within specified limits.*
 - Criterion B: Temporary loss of performance from which the unit self-recovers.*
- WEIGHT:** 15.1 oz (428 g)

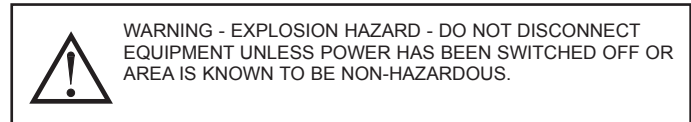

HARDWARE INSTALLATION

DIN rail should be mounted horizontally so that the unit's ventilation holes are vertical in relation to cabinet orientation. A minimum clearance of 1 inch (25.4 mm) should be maintained above and below the unit in order to ensure proper thermal regulation.

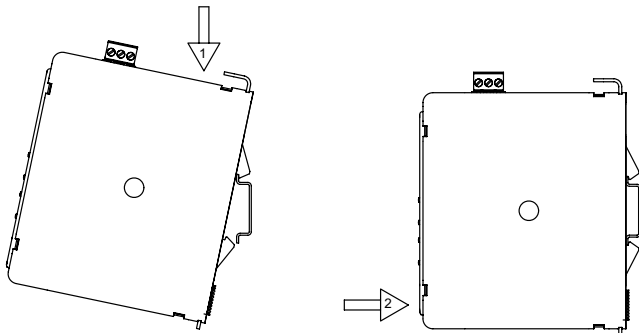
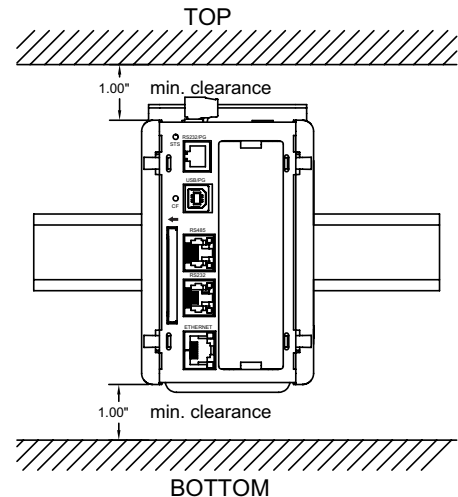
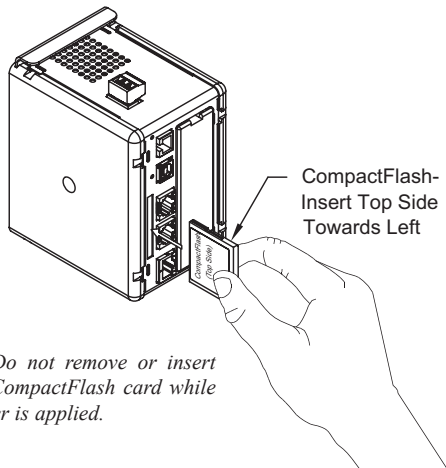

Figure 1 - Attach Fieldbus Gateway To DIN Rail



COMPACTFLASH® CARD

CompactFlash socket is a Type II socket that can accept either Type I or II cards. Use cards with a minimum of 4 Mbytes and a maximum of 2 Gbytes with the Fieldbus Gateway's CompactFlash socket. Cards are available at most computer and office supply retailers. CompactFlash can be used for configuration transfers, data logging, and trending.



Note: Do not remove or insert the CompactFlash card while power is applied.

Information stored on a CompactFlash card can be read by a card reader attached to a PC. This information is stored in IBM (Windows®) PC compatible FAT16 file format.

NOTE

For reliable operation of this and other B&B products, one of the following brands of CompactFlash card must be used...

SimpleTech SMART® Modular
SanDisk® Silicon Systems

Not all of the above manufacturers offer CompactFlash cards recognized to UL standards, which may be required for your application.

POWER SUPPLY REQUIREMENTS

It is very important that the power supply is mounted correctly if the unit is to operate reliably. Please take care to observe the following points:

- The power supply must be mounted close to the unit, with usually not more than 6 feet (1.8 m) of cable between the supply and the Fieldbus Gateway. Ideally, the shortest length possible should be used.
- The wire used to connect the Fieldbus Gateway's power supply should be at least 22-gage wire. If a longer cable run is used, a heavier gage wire should be used. The routing of the cable should be kept away from large contactors, inverters, and other devices which may generate significant electrical noise.
- A power supply with an NEC Class 2 or Limited Power Source (LPS) and SELV rating is to be used. This type of power supply provides isolation to accessible circuits from hazardous voltage levels generated by a mains power supply due to single faults. SELV is an acronym for "safety extra-low voltage." Safety extra-low voltage circuits shall exhibit voltages safe to touch both under normal operating conditions and after a single fault, such as a breakdown of a layer of basic insulation or after the failure of a single component has occurred.

EMC INSTALLATION GUIDELINES

Although B&B Electronics Products are designed with a high degree of immunity to Electromagnetic Interference (EMI), proper installation and wiring methods must be followed to ensure compatibility in each application. The type of the electrical noise, source or coupling method into a unit may be different for various installations. Cable length, routing, and shield termination are very important and can mean the difference between a successful or troublesome installation. Listed are some EMI guidelines for a successful installation in an industrial environment.

1. To reduce the chance of noise spikes entering the unit via the power lines, connections should be made to a clean source. Connecting to circuits that also power loads such as contactors, relays, motors, solenoids etc. should be avoided.
2. The unit should be mounted in a metal enclosure, which is properly connected to protective earth.
3. Use shielded (screened) cables for all Signal and Control inputs. The shield (screen) pigtail connection should be made as short as possible. The connection point for the shield depends somewhat upon the application. Listed below are the recommended methods of connecting the shield, in order of their effectiveness.
 - a. Connect the shield to earth ground (protective earth) at one end where the unit is mounted.
 - b. Connect the shield to earth ground at both ends of the cable, usually when the noise source frequency is over 1 MHz.
 - c. Connect the shield to common of the Fieldbus Gateway and leave the other end of the shield unconnected and insulated from earth ground.

4. Never run Signal or Control cables in the same conduit or raceway with AC power lines, conductors feeding motors, solenoids, SCR controls, and heaters, etc. The cables should be run through metal conduit that is properly grounded. This is especially useful in applications where cable runs are long and portable two-way radios are used in close proximity or if the installation is near a commercial radio transmitter. Also, Signal or Control cables within an enclosure should be routed as far away as possible from contactors, control relays, transformers, and other noisy components.
5. Long cable runs are more susceptible to EMI pickup than short cable runs. Therefore, keep cable runs as short as possible.
6. In extremely high EMI environments, the use of external EMI suppression devices is effective. The following EMI suppression devices (or equivalent) are recommended:

Ferrite Suppression Cores for signal and control cables:

Fair-Rite part number 0443167251
TDK part number ZCAT3035-1330A
Steward part number 28B2029-0A0

Line Filters for input power cables:

Schaffner part number FN610-1/07
Schaffner part number FN670-1.8/07
Corcom part number 1 VR3

WIRING

POWER CONNECTION

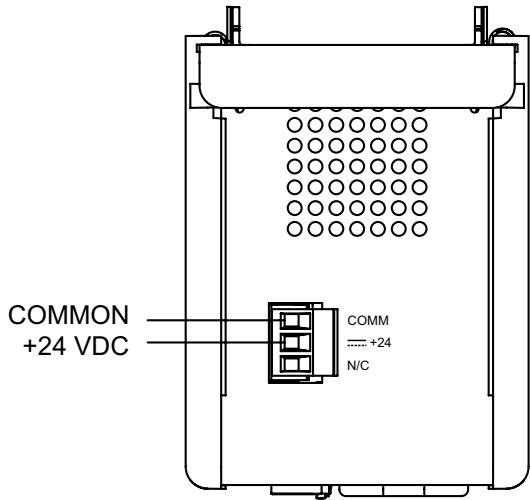

 **WARNING - EXPLOSION HAZARD - DO NOT DISCONNECT WHILE CIRCUIT IS ALIVE UNLESS AREA IS KNOWN TO BE NON-HAZARDOUS.**

 **INPUT AND OUTPUT (I/O) WIRING MUST BE IN ACCORDANCE WITH CLASS I, DIV. 2 WIRING METHODS AND IN ACCORDANCE WITH THE AUTHORITY HAVING JURISDICTION.**

PROGRAMMING PORTS

RS232/PG

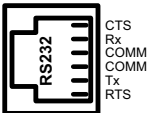

USB/PG



ETHERNET

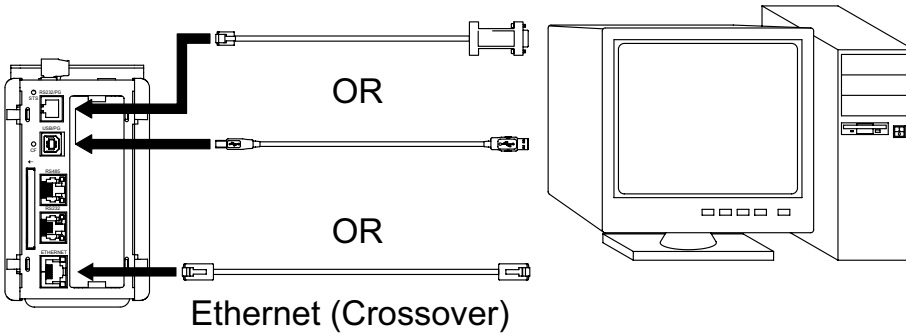

COMMUNICATION PORTS

RS232/PG

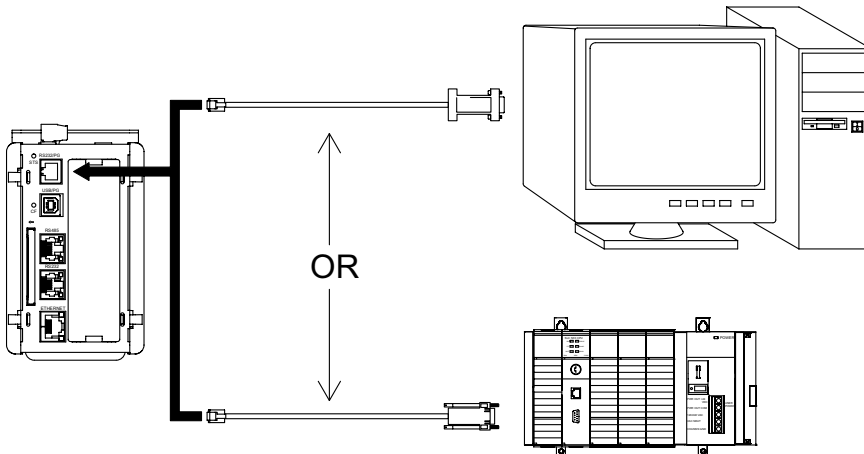
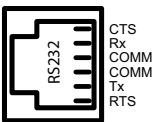

RS232

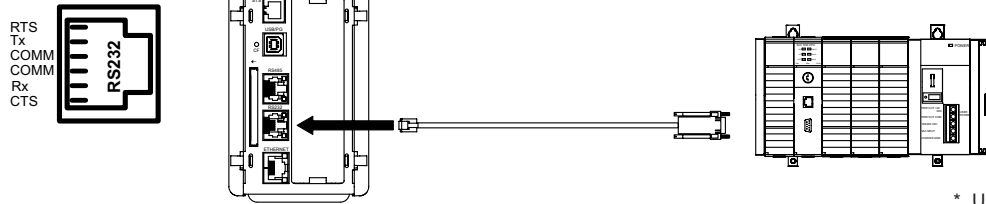

* Use appropriate communications cable. See Ordering Information for descriptions of the available cables.

RS485

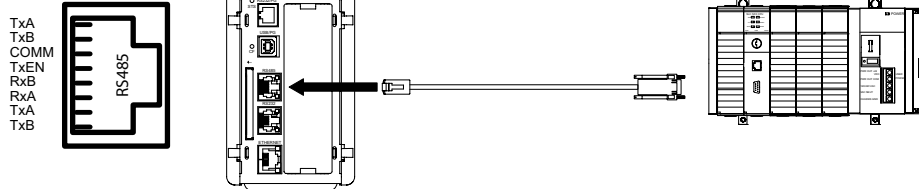

WARNING: Do **NOT** use a standard DH-485 cable to connect this port to Allen Bradley equipment.

PORT 3 - ETHERNET CONNECTION

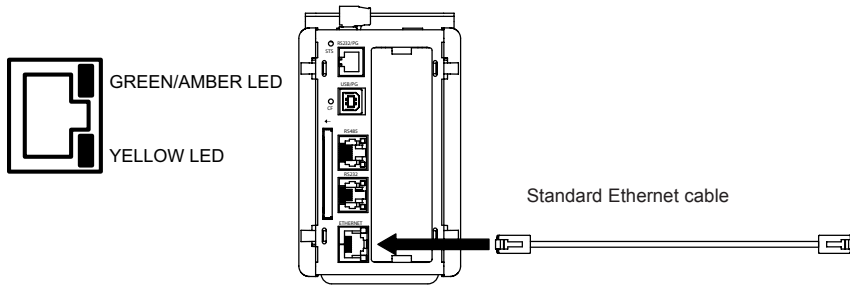

FIELDBUS GATEWAY PORT PIN OUTS

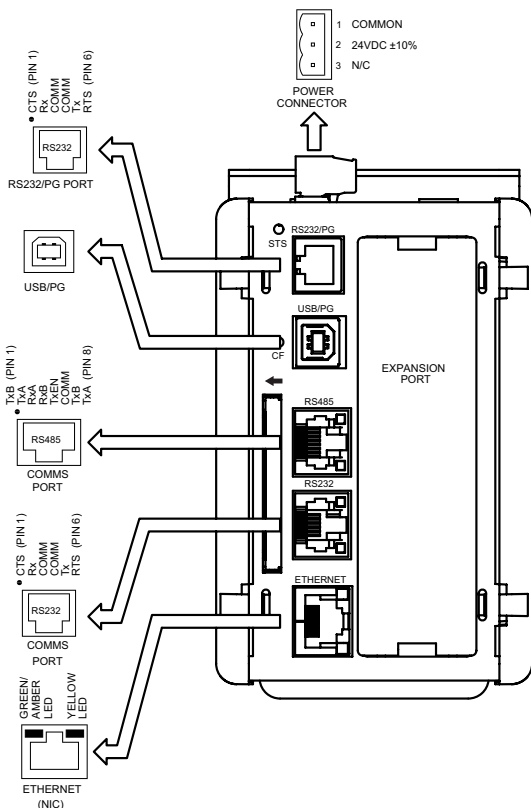

TROUBLESHOOTING

If for any reason you have trouble operating, connecting, or simply have questions concerning your new Fieldbus Gateway, contact B&B Electronic's technical support. For contact information, refer to the back page of this bulletin for phone and fax numbers.

Web Site: <http://www.bb-elec.com>

COMMUNICATING WITH THE FIELDBUS GATEWAY

CONFIGURING A FIELDBUS GATEWAY

The Fieldbus Gateway is configured using Fieldbus Gateway Manager. Updates to the software for new features and drivers are posted on the website as they become available. By configuring the Fieldbus Gateway using the latest version of the software, you are assured that your unit has the most up to date feature set. The software can configure the Fieldbus Gateway through the RS232/PG port, USB/PG port, Ethernet, or CompactFlash. The USB/PG port is connected using a standard USB cable with a Type B connector.

The driver needed to use the USB port will be installed with the software. The RS232/PG port uses a programming cable made by B&B to connect to the DB9 COM port of your computer. If making your own cable, refer to the "Fieldbus Gateway Port Pin Outs" for wiring information.

The CompactFlash can be used to program a Fieldbus Gateway by placing a configuration file and firmware on the CompactFlash card. The card is then inserted into the target Fieldbus Gateway and powered.

CABLES AND DRIVERS

B&B has a wide range of cables and drivers for use with many different communication types. A list of these drivers and cables along with pin outs is available from B&B's website. If making your own cable, refer to the "Fieldbus Gateway Port Pin Outs" for wiring information.

USB, DATA TRANSFERS FROM THE COMPACTFLASH CARD



WARNING - DO NOT CONNECT OR DISCONNECT CABLES WHILE POWER IS APPLIED UNLESS AREA IS KNOWN TO BE NON-HAZARDOUS. USB PORT IS FOR SYSTEM SET-UP AND DIAGNOSTICS AND IS NOT INTENDED FOR PERMANENT CONNECTION.

In order to transfer data from the CompactFlash card via the USB port, a driver must be installed on your computer. This driver is installed with the software and is located in the folder C:\Program Files\B&B Electronics\Vlinx Fieldbus Gateway Manager\Device after the software is installed. This may have already been accomplished if your Fieldbus Gateway was configured using the USB port.

Once the driver is installed, connect the Fieldbus Gateway to your PC with a USB cable, and follow "Mounting the CompactFlash" instructions in the Fieldbus Gateway Manager user manual.

Note that using the USB port for frequent data transfers is not recommended. For frequent data transfers it is recommended that the Ethernet connection be used. Through the Ethernet connection a web page can be set up to view logged data. Refer to the Fieldbus Gateway Manager manual for details.

Note: The USB port is for system set-up and diagnostics and is not intended for permanent connection.

ETHERNET COMMUNICATIONS

Ethernet communications can be established at either 10 BASE-T or 100 BASE-TX. The Fieldbus Gateway's RJ45 jack is wired as a NIC (Network Interface Card). For example, when wiring to a hub or switch use a straight-through cable, but when connecting to another NIC use a crossover cable.

The Fieldbus Gateway Manager manual contains additional information on Ethernet communications.

RS232 PORTS

The Fieldbus Gateway has two RS232 ports. There is the RS232/PG port and the COMMS port. Although only one of these ports can be used for programming, both ports can be used for communications with a PLC. The RS232/PG port can be used for either master or slave protocols.

RS422/485 PORT

The Fieldbus Gateway has one RS422/485 port. This port can be configured to act as either RS422 or RS485.

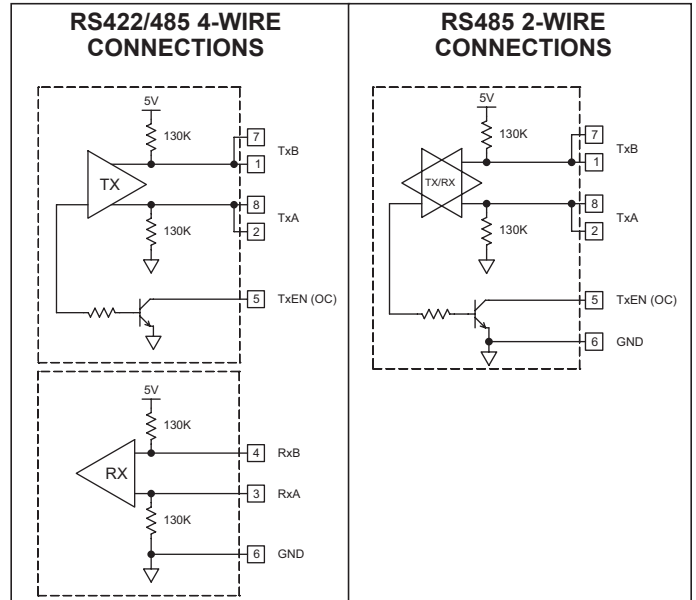

Note: All B&B devices connect A to A and B to B.

DH485 COMMUNICATIONS

The Fieldbus Gateway's RS422/485 COMMS port can also be used for Allen Bradley DH485 communications.

WARNING: DO NOT use a standard DH485 cable to connect this port to Allen Bradley equipment. A cable and wiring diagram are available from B&B.

LEDS

STS – STATUS LED

The green Status LED provides information regarding the state of the Fieldbus Gateway. This includes indication of the various stages of the start-up routine (power-up), and any errors that may occur.

Startup Routine

	INDICATION
Rapidly Flashing	Fieldbus Gateway is currently running the boot loader and/or being flash upgraded by the software.
Steady	Fieldbus Gateway is operating properly.

CF – COMPACTFLASH LED

LED	INDICATION
Off	No CompactFlash Card is present.
Steady	Valid CompactFlash card is present.
Flashing Rapidly	CompactFlash card is being checked.
Flickering	Unit is writing to the CompactFlash, either because it is storing data, or because the PC connected via the USB port has locked the drive. ¹
Flashing Slowly	Incorrectly formatted CompactFlash card present.

¹ Do not turn off power to the unit while this light is flickering. The unit writes data in two minute intervals. Later Microsoft operating systems will not lock the drive unless they need to write data; Windows 98 may lock the drive any time it is mounted, thereby interfering with logging. Refer to "Mounting the CompactFlash" in the Fieldbus Gateway Manager User Manual.

USER COMMUNICATION PORTS - TX/RX LEDS

LED	INDICATION
GREEN	Transmitting
RED	Receiving

Note: LEDs are not available on the Programming Port: RS232/PG.

ETHERNET LEDS

LED	INDICATION
YELLOW (Solid)	Link Established
YELLOW (Flashing)	Network Activity
GREEN	10 BASE-T Communications
AMBER	100 BASE-TX Communications

ORDERING INFORMATION

TYPE	MODEL NO	DESCRIPTION	PART NUMBER
Fieldbus Gateway	VFG	Fieldbus Gateway with multiple protocol converter, data logger, web server with Virtual HMI up to QVGA (320 x 240) and expansion slot.	VFG2000
		Fieldbus Gateway with multiple protocol converter, data logger, web server with Virtual HMI up to VGA (640 x 480) size and expansion slot with increased SDRAM.	VFG3000
Communications Cables (10 feet)	CBL	RS-232 Programming Cable	CBL01500
		USB Cable	USBAMB6-6F
		Communications Cables ¹	CBLxxxx
Accessories	VFG9	CANopen option card for Fieldbus Gateway	VFG9000-CAN
		GSM/GPRS Cell Modem Option Card for Fieldbus Gateway	VFG9000-CEL
		DeviceNet option card for Fieldbus Gateway	VFG9000-DN
		PROFIBUS option card for Fieldbus Gateway	VFG9000-PBDP
		RS232/485 option card for Fieldbus Gateway	VFG9000-SERIAL

¹ Visit www.bb-elec.com for a list of communication drivers and cables.

B&B Electronics
International Headquarters
707 Dayton Road
P.O. Box 1040
Ottawa, IL 61350
Phone: (815) 433-5100
Fax: (815) 433-5104

B&B Electronics Ltd
European Headquarters
Westlink Commercial Park,
Oranmore, Co. Galway, Ireland
Phone: +353 91 792444
Fax: +353 91 792445